

MONSTER 1200





Index

Better.Faster.Monster.	2
Timeless icon	5
Essential, refined lines	6
Stylish even in the details	8
The latest evolution of the Testastretta 11°	12
Easy and safe riding	14
Sports-riding ergonomics	15
Advanced technology	17
Monster instinct	18
Absolute Sports performance	21
Servicing and maintenance	22
Technical data and gear	25
The perfect Monster for you	34
Apparel	41

Better.
Faster.
Monster.

The Monster 1200 has evolved, while remaining faithful to the values that made Monster such a unique bike. This translates into an essential, technological bike, in which the innate sporty nature is emphasised by its compact dimensions and agile bike settings that ensure handling and maximum riding enjoyment. Elements that match perfectly with the latest evolution of the Ducati Testastretta 11° DS engine, which unleashes a power of 147hp and 12.6 kgm of torque and is always ready to respond whatever the speed.





Timeless icon

The design of the Monster 1200 is both contemporary and iconic, characterised by particular attention to detail, the tank fastener being just one example, a stylistic throwback to the very first model. An unmistakable model that is a modern take on the original concept of the bike created in 1993. The muscular lines, trellis frame and characteristic elements such as the slender rear end and classic round headlight, iconic yet modern, featuring DRL technology on the S version, solidify its role as a modern-day icon.

Essential,
refined lines

Further contributing to the compactness and sporty nature of the Monster 1200 are the proportions and curves of the tank that recall the iconic Monster lines, with a modern, sophisticated twist. Riding comfort is guaranteed by the deep grooves on the sides of the tank and the perfect alignment of the intersection zone with the seat.





Stylish even in the details

With the Monster 1200, essentiality takes on a more highly evolved form, perfectly combining highly sophisticated content with the utmost attention to detail. For this reason, great care has been paid to the surfaces that characterise the super structure, reinterpreted to great effect, and to the wheel design, 10-spoke for the Monster 1200 and 3-spoke 'Y' for the Monster 1200 S. The single-sided swingarm has been completely redesigned to reduce the dimensions of the wheelbase and to ensure maximum manoeuvrability of the bike.



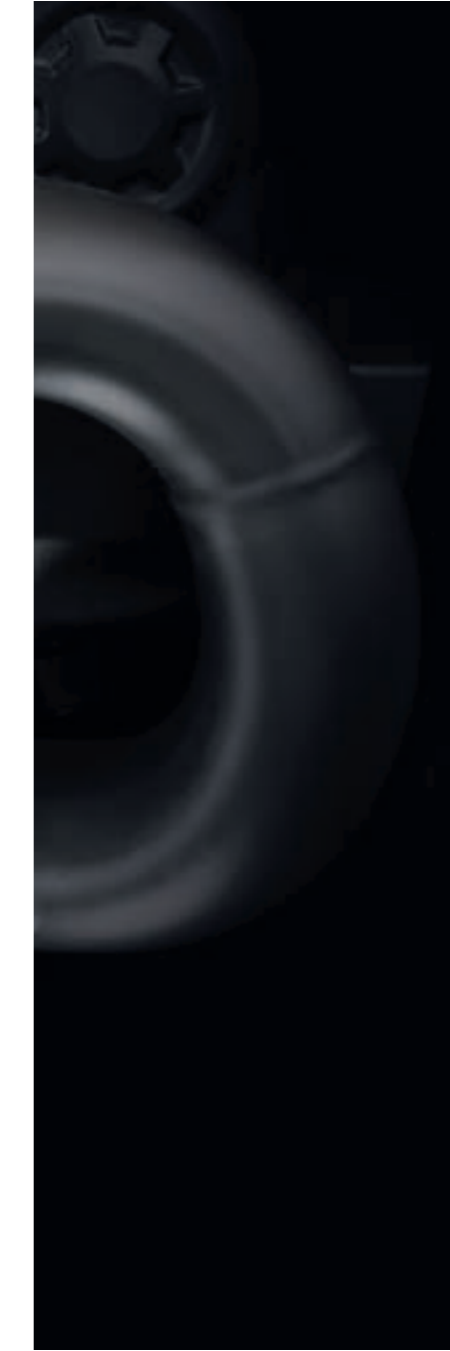

The latest evolution of the Testastretta 11°

The Testastretta 11° DS Euro 4 homologated engine provides an ever-ready, full supply at all speeds and 147 hp maximum power at 9250 rpm, the Monster 1200 offers the sheer enjoyment and excitement of a true sports bike. Thanks to the oval throttle bodies with 56 mm diameter and compression ratio of 13:1, the 1198 cc twin boasts a substantial torque curve with a peak of 12.6 kgm at 7750 rpm and over 10 kgm available between 3000 to over 10000 rpm. Great attention has also been paid to improving supply at low speeds, and to engine response when the throttle is opened, in order to ensure smooth delivery in all conditions.

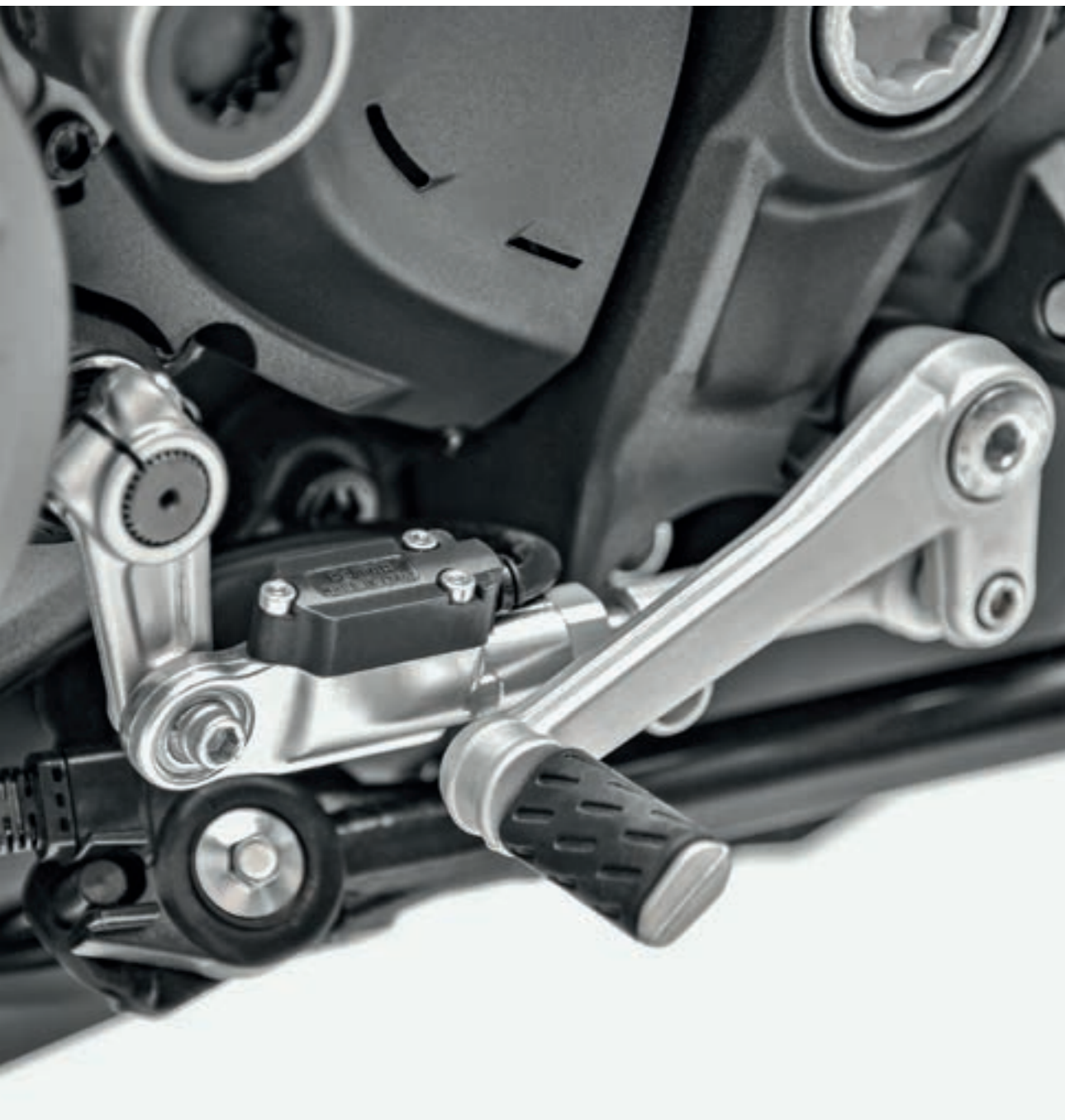

Standout chassis and equipment

The chassis of the Monster 1200 has been designed to offer the maximum in terms of handling and riding enjoyment. Brakes and suspension are of a high level, for safe enjoyment with optimum control. The Brembo braking system, with M50 radial monobloc callipers on 330 mm discs for the S version, ensures powerful, precise and safe braking, thanks also to interaction with latest generation Cornering ABS, highly effective even when leaning. The suspension, with fully adjustable Öhlins fork and shock on the S version, allows for sports riding without compromise. The Ducati Quick shift up/down, the race-derived electronics system, allows for clutch-free shifting, with no need to close the throttle when upshifting. As standard on the Monster 1200 S and available as an accessory for the standard version.





Sports-riding ergonomics

The compact design and sports attitude of the Monster 1200 are the result of careful design and detailed studies in ergonomics. Particularly the short tail, compact and pointing upwards, expresses dynamism and lightness from the first glance, as well as supporting the seat with, height adjustable in two positions (795 and 820 mm). In addition, a brand new steel trellis sub-frame also supports the passenger footpegs, now separate from the rider's. This configuration gives the Monster 1200 an even more sporty line and improves interaction between the bike and rider.



Advanced technology

The Monster 1200 is equipped with an advanced electronics package that enhances performance and helps the rider to control the bike, improving the safety level on any route and in any conditions. The Monster has mounted the Inertial Measurement Unit, IMU, allowing for the differentiated operation of the ABS when leaning (Cornering ABS) and heightened control with Ducati Wheelie Control.

The equipment also includes the Ducati Safety Pack (Cornering ABS and Ducati Traction Control), Ride by Wire and the Riding Modes (Sport, Urban and Touring). Each Riding Mode is associated with pre-set levels of engine power/delivery, DWC, DTC and ABS. The rider can modify the intervention of each device to create a personalised Riding Mode to suit the conditions of use.

Another characteristic element of the Monster 1200 is the front headlight. Completely redesigned, it includes a double parabola and, on the Monster 1200 S, also a DRL (Day Time Running Light). This light has allowed for a different dash support, attached to the handlebar risers. The front headlight also benefits from a LED position light. LED lighting technology is also applied to the rear light and turn signals (on the S version), while the dashboard features a latest-generation colour TFT display. The fuel level and gear in use are always visible.

Monster instinct

Perfectly balanced in terms of engine, chassis and electronics, the Monster 1200 offers exciting dynamic behaviour, for maximum riding enjoyment. The resulting bike is able to boast a unique performance, thanks to the full and powerful engine, compact dimensions, efficient chassis and high level electronics package. Quick when changing direction, precise on corner-entry and efficient when it comes to acceleration, the Monster always ensures the sensation of control and handling which puts the rider at ease. All of this, plus a superbike braking system, the best of Ducati technology in terms of safety and the possibility of adapting to the specific conditions of use, allowing the Monster 1200 to express its sports attitude safely and intuitively.





S Equipment Absolute Sports performance

The dynamic qualities and performance of the Monster 1200 are emphasised with the S version, which accentuates the sports essence with advanced components. Standard equipment includes a 48mm Öhlins fork and a single Öhlins shock, both fully adjustable. The braking system consists of two 330 mm Brembo discs paired with Brembo M50 monobloc callipers, the same as those on the Panigale. The Monster 1200 S is also equipped with the Ducati Quick Shift up/down (DQS) system as standard, 3-spoke 'Y' rims with an exclusive "S" graphic and a carbon fibre front mudguard. The turn signals are LED and the front headlight is characterised by the DRL (Daytime Running Light), which guarantees immediate identification as well as maximum safety during daytime use. The extreme sports attitude of the Monster 1200 S is also underlined by the exclusive Black on Black livery with Racing Red details, which flanks the classic Ducati Red version with red frame and black wheels.

Servicing and maintenance

Safety as standard

The continuous work that Ducati carries out in terms of design, research and development serves to ensure cutting edge bikes characterised by maximum active safety levels. A commitment that involves the definition of increasingly advanced technological systems to boost the rider's level of control, such as the Ducati Safety Pack (DSP) which, for the Monster 1200 and Monster 1200 S, includes 9.1MP ABS and Ducati Traction Control (DTC), both adjustable. The equipment that enhances the bike's dynamic performance in both braking and acceleration and, in this case, thanks to the Inertial Measurement Unit (IMU), also integrates the 9.1MP Cornering ABS function, which allows the system to also operate effectively through the turns.

More value to your passion

With Ever Red, the quality and reliability of the Ducati brand remain your inseparable travelling companions over time. Ever Red is the exclusive Ducati warranty extension programme. With its activation you can continue to feel protected for 12 or 24 months beyond the expiration of the Ducati Warranty (24 months). Ever Red includes roadside assistance for the entire coverage period and no mileage limits. In this way you can ride for all the kilometres you want, even abroad, enjoying your Ducati without any worries.

To find out if the Ever Red extension is available in your country and for further information contact your Ducati dealer or visit ducati.com.

Endless excitement

In designing each bike, Ducati constantly strives to ensure maximum reliability while reducing service costs. A commitment that has seen the intervals for the main Desmo Service, in which valve clearance is checked and adjusted if necessary, to be extended to 30,000 km for the Monster 1200. Even the simplest of checks, such as the Oil Service, are extended to 15,000 km or 12 months.

A considerable interval for such exceptional performance engines, which only confirms the high quality standards adopted in terms of material selection and R&D processes. Ducati continuously invests in the technical training of its dealers.

The specific skills offered by the official Ducati Service network ensure that all operations needed to keep every Ducati in perfect condition are thoroughly executed. While advanced equipment such as the Ducati Diagnosis System allows the software on each Ducati to be updated with the latest releases, ensuring that the electronics continue to perform at the maximum level.

Always by your side

One of Ducati's main goals is to offer every Ducatista the chance to enjoy unlimited and safe travel all over the world. To achieve this aim, Ducati offers a "fast delivery" original spares service, with delivery in 24/48 hours across 85% of the areas in which it operates. With a distribution network that covers more than 86 countries, thanks to 718 official Dealers and Service Points*, choosing a Ducati means you can travel worry-free and in total freedom, wherever the road may take you, and count on capillary support that ensures Ducati quality and professionalism is always close at hand.

718 Authorised dealers and service points

86 World countries

*Information updated as of July 2019



Ever Red
Extended Warranty



*Equal to 18,000 miles.





Technical data and gear

MONSTER 1200

Dimensions

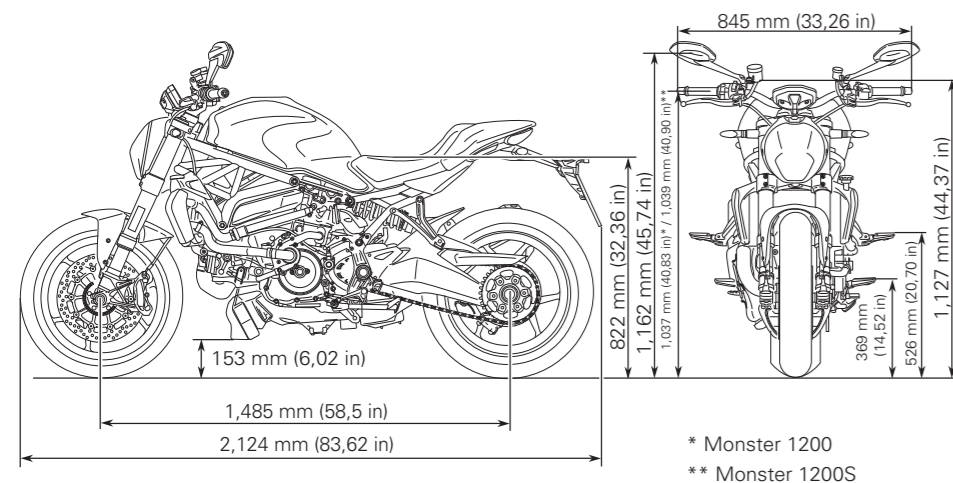

Power and torque

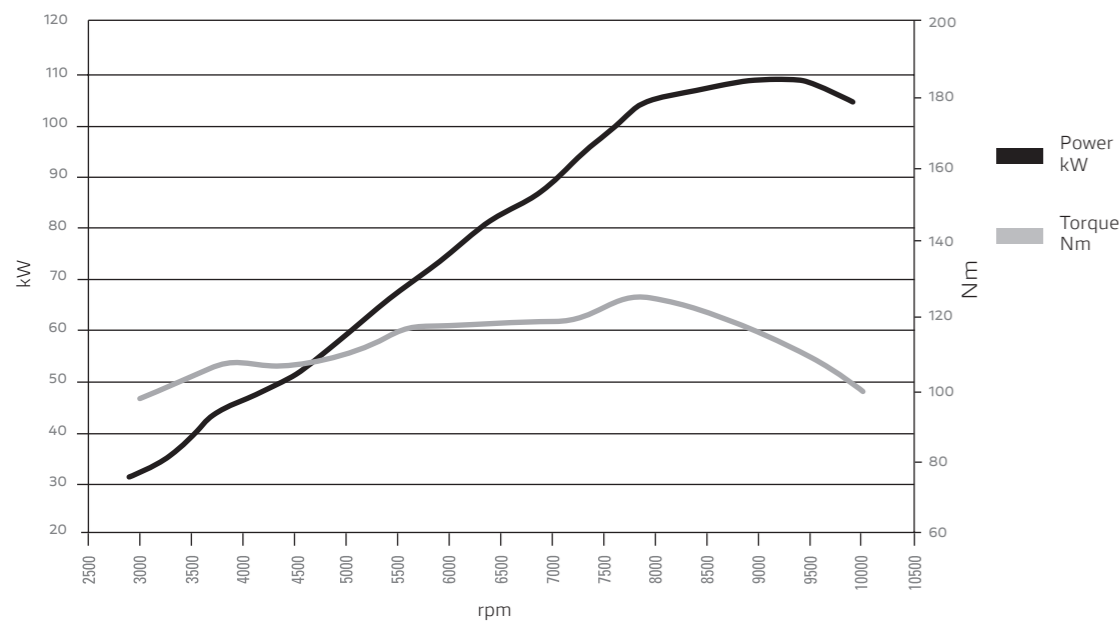

Engine	
Type	Ducati Testastretta 11°, L-Twin, 4 Desmodromically actuated valves per cylinder, Dual spark, Liquid cooled
Displacement	1,198 cc (72.9 cu in)
Bore X Stroke	106 x 67.9 mm (4.17 x 2.67 in)
Compression ratio	13.0:1
Power	147 hp (108 kW) @ 9,250 rpm
Torque	124 Nm (91 lb-ft, 12.6 kgm) @ 7,750 rpm
Fuel injection	Electronic fuel injection system, Full ride-by-wire system, Øeq 56 mm oval throttle bodies
Exhaust	Lightweight 2-1-2 system with catalytic converter and two lambda probes, Twin stainless steel mufflers with aluminium covers and end caps
Transmission	
Gearbox	6 speed
Primary drive	Straight cut gears, ratio 1.84:1
Ratio	1=37/15 2=30/17 3=27/20 4=24/22 5=23/24 6=22/25
Final drive	Chain drive, front sprocket Z15, rear sprocket Z 41

Transmission	
Clutch	Slipper and self-servo wet multiplate clutch with hydraulic control
Chassis	
Frame	Tubular steel trellis frame attached to the cylinder heads
Front Suspension	Ø 43 mm fully adjustable usd fork
Front wheel	10-spoke light alloy, 3.50" x 17"
Front tyre	Pirelli Diablo Rosso III, 120/70 ZR17
Rear Suspension	Progressive linkage with monoshock, preload and rebound adjustable, Aluminium single-sided swingarm
Rear wheel	10-spoke light alloy, 6.00" x 17"
Rear tyre	Pirelli Diablo Rosso III, 190/55 ZR17
Wheel travel (front/rear)	130 mm/149 mm (5.12 in/5.87 in)
Front brake	2 x Ø 320mm semi-floating discs, radially mounted monobloc Brembo M4.32 callipers, 4-piston, radial pump with Cornering ABS as standard equipment
Rear brake	Ø 245 mm disc, 2-piston calliper with Cornering ABS as standard equipment
Instrumentation	Full-TFT colour display

Dimensions and weight	
Dry weight	187 kg (412 lb)
Wet weight	213 kg (470 lb)
Seat height	Adjustable 795 - 820 mm (31.30 - 32.28 in)
Wheelbase	1,485 mm (58.46 in)
Rake	23.3°
Trail	86.5 mm (3.41 in)
Fuel tank Capacity	16.5 l (4.36 US gal)
Number of seats	2
Standard equipment	
Riding Modes, Power Modes, Ducati Safety Pack (Cornering ABS + Ducati Traction Control), Ducati Wheelie Control (DWC), Ride by Wire (RbW), TFT color display, Passenger seat cover, LED position light and tail light, USB power socket. Predisposed for the anti-theft system, Ducati Multimedia System (DMS), Ducati Data Analyzer (DDA), and Ducati Quick Shift up/down (DQS)	
Warranty	
Warranty	24 months
Maintenance	
Maintenance service intervals	15,000 km (9,000 mi) / 12 months
Valve clearance check	30,000 km (18,000 mi)

Emissions & consumption*	
Standard	Euro 4
CO2 Emissions	119 g/km
Consumption	5.2 l/100 km



Equal to 18,000 miles

Indication of mileage at the first Desmo Service, or rather the first service during which valve clearance is checked and adjusted if necessary.

* Only for countries where Euro 4 standard applies.

MONSTER 1200

Ducati Red



MONSTER 1200 S

	Monster 1200	Monster 1200 S
Ducati Quick Shift up/down (DQS)	Accessory	Standard equipment
Front suspension	Ø 43 mm fork	Ø 48 mm Öhlins fork
Front/Rear wheel	10-spoke	Y shaped 3-spoke with "S" graphics
Rear suspension	Monoshock, preload and rebound adjustable	Öhlins fully adjustable monoshock
Front brake	2 x Ø 320 mm discs, Brembo M4.32 callipers	2 x Ø 330 mm discs, Brembo M50 callipers
DRL	-	Standard equipment*
Side indicators	Lamp	LED*
Front mudguard	Plastic	Carbon fiber
Dry weight	187 kg (412 lb)	185 kg (408 lb)
Weight in running order	213 kg (470 lb)	211 kg (465 lb)

* Please check product availability with your Dealer



1 Fully adjustable Öhlins front and rear suspension



2 Headlight with Daytime Running Light (DRL)



3 Front brakes with Ø 330 mm discs and Brembo M50 radial monoblock callipers

MONSTER 1200 S

Ducati Red



Black on Black





Complete exhaust assembly

The perfect Monster for you

Versatility and also freedom to change. Whatever your customisation needs, it is easy with the Sport personalisation pack and the wide range of Ducati Performance accessories available. Sports exhausts, cast aluminium parts, billeted aluminium details, seats of different heights, equipment for travelling: details that make the Monster 1200 even more unique, adapting it to suit any requirements.

Try the online configurator and customise your new Ducati bike at configurator.ducati.com





1 Carbon rear mudguard



2 Carbon instrument cover



3 Carbon heat guard



4 Carbon chain guard



1 Billet aluminium rearview mirrors



2 Billet aluminium water pump cover



3 Aluminium number plate holder



Apparel

Speed Evo
Full-face helmet

Redline B1
Preformed knapsack

Ducati Corse C4
Leather jacket

Ducati Apparel Collection designed by *Drudi Performance*



Ducati Corse tex C4
Fabric jacket



Speed Evo C1
Leather jacket

For more information on the apparel collection go to a Ducati Dealership or visit the site ducati.com



Speed Evo C1
Leather jacket

Speed Evo
Full-face helmet

For more information on the apparel collection go to a Ducati Dealership or visit the site ducati.com





Downtown C1
Leather jacket





Company C3
Leather jacket

Company C3
Technical jeans

Peak V3
Full-face helmet

Key to symbols

 This product is intended for racing vehicles used only in closed-course competition. Operation on public roads is prohibited by law.

 For racing use only. The product marked with this symbol can only be used on competition vehicles. Use outside a competition track of motorcycles equipped with this product is prohibited by law. Verify any further restrictions with the relevant race course. Motorcycles equipped with this accessory are prohibited from operating on public roads.

 This accessory is not approved for road circulation.

 Accessory type-approved for road use.

 Anodized

 Matt

 Tinted

 Liquid concrete gray

 Silver

 Black

 Red

 Gold

 Right

 Left

ducati.com

Riding a motorcycle is the most exciting way to enjoy the road, and offering the utmost safety to the motorcyclist is Ducati's commitment. Ducati bikes are increasingly easy to handle, reliable and better equipped to guarantee maximum safety and enhance riding pleasure. Technical clothing is made with even more advanced materials for adequate protection and increased visibility. The safety of motorcyclists is Ducati's commitment. For more information visit the safety section of the Ducati site (www.ducati.com).

WARNING: The photos and technical information in this catalogue may refer to prototypes subject to modifications during production and are purely for illustration and reference purposes, and are therefore not binding on Ducati Motor Holding S.p.A. Sole Shareholder Company - Company subject to the direction and coordination of AUDI AG ("Ducati"). Ducati cannot be held responsible for any print and/or translation errors. This catalogue is transnational and therefore some products may not be available and/or their features may vary in accordance with local laws. Not all colours and versions are available in each country. Ducati reserves the right to make changes and improvements to any product without obligation of prior notice or to make such changes to products already sold. Further characteristics of the products are contained in the owner's manuals. The products represented are not definitive versions and are therefore subject to significant changes at Ducati's discretion without prior notice. The photographs published in this catalogue show only professional riders under controlled street conditions. Do not attempt to imitate such riding behaviour as it could be dangerous for you or other people on the road. This catalogue, including but not limited to the trademarks, logos, texts, images, graphics and table of contents herein, constitute Ducati intellectual property, or in any event Ducati has the right to reproduce it; any reproduction, modification or other whole or partial use of the catalogue or its contents, including publication on the Internet without the prior written consent of Ducati, is prohibited.

Actual fuel consumption may vary based on many factors, including but not limited to riding style, maintenance performed, weather conditions, surface characteristics, tyre pressure, load, weight of the rider and the passenger, accessories.

Ducati indicates the dry weight of the motorcycle excluding battery, lubricants and coolants for liquid-cooled models. The weights in running order are considered with all operating fluids, standard equipment and the fuel tank filled to 90% of its useful capacity (UE regulation no. 168/2013). For more information visit www.ducati.com. November 2019.



DUCATI

MONSTER 1200

Developed with



Technical partner



WDW2020
WORLD DUCATI WEEK
17 - 19 Luglio / Misano, Italia
wdw.ducati.com