

HYPERMOTARD





Index

Game on!	3
Riding the thrill	4
Motard style	6
Ducati Testastretta 11°	9
A chassis built to entertain	11
Advanced electronics	15
Pure enjoyment	17
Hyper adrenaline	21
Apparel	22
Servicing and maintenance	28
Technical data and equipment	30
Accessories	39



Game on!

Aggressive in appearance, sporty in nature. With the Hypermotard 950, the excitement just keeps on coming. A wide handlebar, narrow sides, and weight reduced by 4 kg make it agile when changing direction. The seat height allows for feet to comfortably reach the ground. The bike is always ready with a response thanks to the Testastretta 11° engine's 114 hp and 9.8 kgm, controlled with modern electronics based on the 6-axis Inertial Measurement Unit (6D IMU). With its appealing look and fearless character, the Hypermotard 950 excites at every turn. Even in the city.

Riding the thrill



From design to performance, the Hypermotard 950 is all about sheer stripped-down adrenaline. Ergonomics are optimised to ensure the rider is in full control and enjoys maximum responsiveness whatever the conditions. The engine, rich in terms of both power and torque, and the excellent handling only add to that high-performance, easy to ride motard temperament. A bike with a unique character, ready to offer excitement and fun.



Motard style



The third generation of Hypermotard reveals its sports roots in the clean lines and streamlined forms, in which the 14.5-litre tank takes up the style of the racing motard. The aggressive look, comprising clean and slender shapes and surfaces, is enhanced by under-tail double silencers, minimal fairings and

the iconic front section, an authentic and distinctive element of all Hypermotard models. From the front, the single headlight with Daytime Running Light (DRL) makes an impact and gives the Hypermotard 950 a technological and modern appearance, for an unmistakable look even during the day.



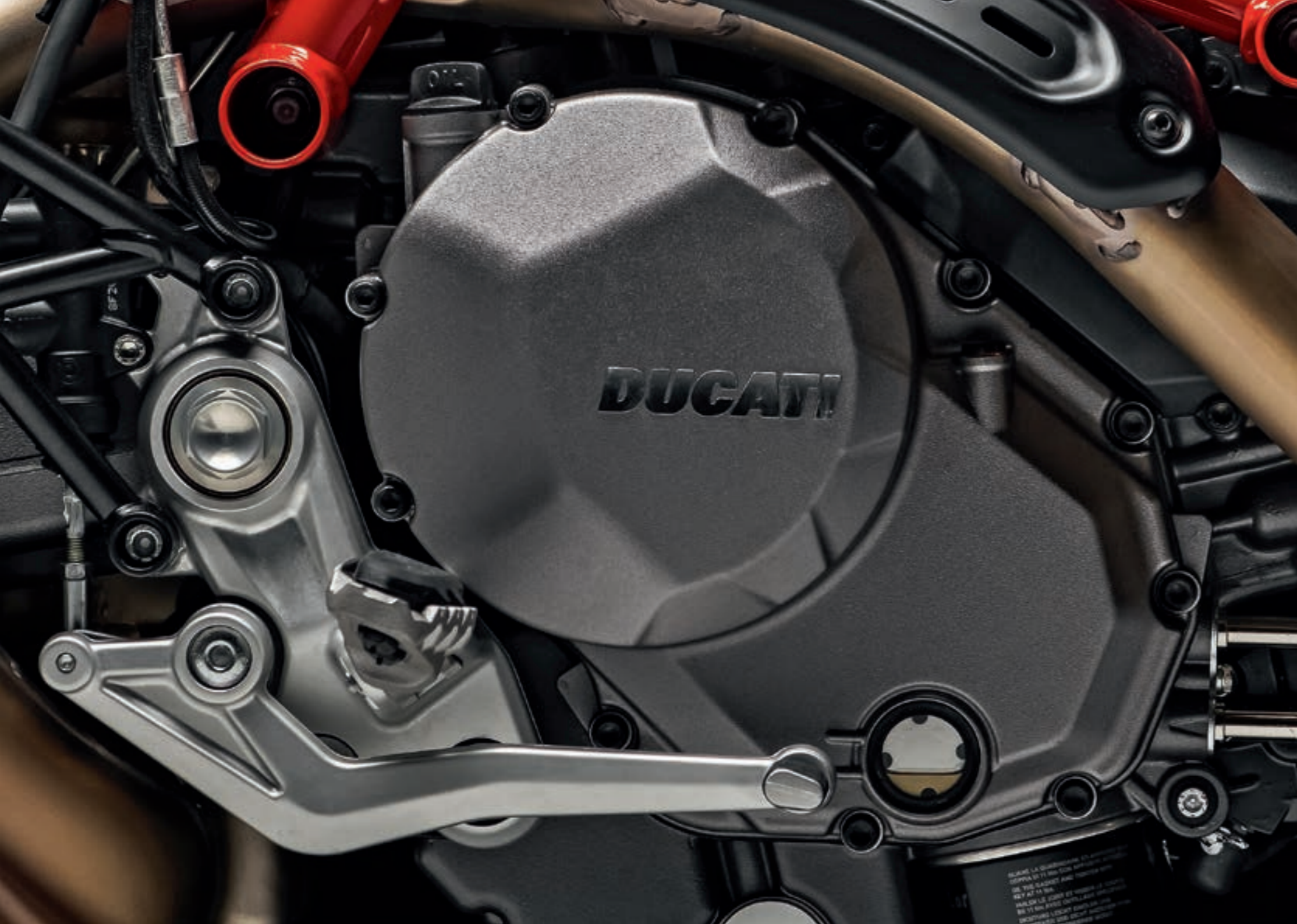

Ducati Testastretta 11°

The Hypermotard 950 mounts the latest evolution of the 937 cc Ducati Testastretta 11°, 1.5 kg lighter and 4 hp more powerful than the previous version, with overall power reaching 114 hp at 9,000 rpm. Torque hits a peak of 9.8 Kgm at 7,250 rpm with a flat curve ensuring significant and continuous drive: 80% of torque is already available at 3,000 rpm, 88% from 5,000 rpm to 9,500 rpm. Performance of this kind is achieved thanks to an increased compression ratio, a exhaust cam profile and a exhaust system with silencers positioned under the seat. The Testastretta 11° is fed by a 53 mm throttle body and controlled by a ECU and Ride-by-Wire gas control, designed to ensure smooth, easy to manage delivery. The Hypermotard 950 twin-cylinder also boasts and more lightweight clutch and alternator covers, a lighter gear shift drum, aluminium belt tensioner, magnesium head covers and a hydraulic-control wet clutch with anti-wheelie function.





A chassis built to entertain

Ergonomics, agility in the changes of direction and stability through the turns: the chassis of the Hypermotard 950 has been created to offer maximum enjoyment and control. The steel trellis frame with variable-section tubes, the 25° steering head angle and the 104 mm front wheel trail with 30 mm offset allow for stable and secure control, while the 1,493 mm wheelbase (1,498 mm for the SP version SP) ensures stability even at high speed. The rear sub-frame has a particularly tapered shape in the area where it connects to the main frame, which has allowed for a narrow-sided saddle, with inner leg reduced by 53 mm to allow the rider to touch the ground more easily with both feet. The variable-section aluminium handlebar serves to support the radial pumps with separate brake/clutch oil tank, controlled with adjustable levers.

When it comes to adrenaline, the suspension has it covered: a fully-adjustable 45 mm Marzocchi fork with aluminium outer tubes and stanchions, with 170 mm travel at the front, and an adjustable Sachs single shock with 150 mm travel at the rear. The SP version offers motard-style riding, the Öhlins suspension ensuring boosted wheel travel (+ 15 mm at the front, + 25 at the rear). At the front, a radial brake master cylinder with adjustable lever operates two Brembo M4.32 monobloc radial 4-piston callipers that act on 320 mm discs with refined aluminium flanges (for a total weight saving of 600 grams), while at the rear we find a single 245 mm disc and a single Brembo calliper.





Advanced electronics

The Hypermotard 950 boasts cutting-edge electronics based on the use of the 6-axis inertial platform, able to instantaneously identify bike roll, pitch and yaw. The electronics package on the Hypermotard 950 comprises: EVO ABS Cornering with Slide by Brake function, Ducati Traction Control (DTC) EVO, Ducati Wheelie Control (DWC) EVO and Ducati Quick Shift (DQS) up/down EVO, available as an accessory or as standard on the SP version. The Hypermotard 950 can be configured according to 3 Riding Modes: Sport, for sports riding on the road, winding routes or on track, the system exploiting the Ducati twin's full 114 hp and offering performance-orientated electronic settings; Touring, ideal for those urban and out-of-town trips and for those who favour a clean, smooth ride, the 114 hp delivered more gently and combined with electronic settings that are more orientated towards safety; Urban, in conditions of low grip, with the Testastretta 11° twin limited to 75 hp and the electronic settings configured for maximum safety.





Pure enjoyment

Agile, precise, responsive, with a centred riding position and a compact, essential design. The Hypermotard 950 is the Ducati "fun-bike" par excellence: perfectly at ease on urban routes, it adapts seamlessly to mountain paths thanks to the responsiveness of the 937 cc Testastretta 11° engine, the efficiency of the suspension and the contribution made by the advanced electronic equipment. Instrumentation on the Hypermotard 950 comprises a 4.3" TFT display with graphics and interface inspired by those of the Panigale V4 which, thanks to explanatory diagrams that detail the system in question, ensure simple menu navigation, prompt identification of the selected Riding Mode and the rapid adjustment of settings. Every moment on board the Hypermotard 950 becomes one of pure enjoyment.



The photographs published in this catalogue show only professional riders under controlled street conditions. Do not attempt to imitate such riding behaviour as it could be dangerous for you or other people on the road.



Hyper adrenaline

The Hypermotard 950 SP is also ready to offer that "Hyper" thrill on track. The dedicated sports livery, the carbon components and the flat, high seat (890 mm) to facilitate sports riding all make for an unmistakable motard character and look. Suspension, courtesy of Öhlins, ensures increased wheel travel, with a 48 mm front fork and rear shock, both fully adjustable and able to ensure a lean angle of 47° (3° greater than the Hypermotard 950). Then, to make it even more track-ready, there is the Ducati Quick Shift (DQS) up/down EVO, Marchesini 3-spoke forged wheels and Pirelli Diablo Supercorsa SP tyres.

Apparel

Explorer

Full-face helmet

Explorer

Goggles

Downtown C1

Leather jacket

Company C2

Leather jacket

Company C3

Technical Jeans

Company C1

Fabric-leather gloves

Downtown

Technical short boots





Ducati Corse K1
Kangaroo leather racing suit
Available also in the
www.ducatisumisura.com programme

Explorer
Full-face helmet

Explorer
Goggles

Speed Evo C1
Leather gloves

Atacama WP C1
Touring-adventure boots

Ducati Apparel Collection designed by **Drudi Performance**





Servicing and maintenance

Safety as standard

The continuous work that Ducati carries out in terms of design, research and development serves to ensure cutting edge bikes characterised by maximum active safety levels. A commitment that involves the definition of increasingly advanced technological systems to increase the rider's level of control, such as the Ducati Safety Pack (DSP) that, for Hypermotard 950, includes Cornering ABS and Ducati Traction Control (DTC). Equipment that optimises the bike's dynamic performance in both braking and acceleration and that offers numerous levels of adjustment with three different intervention levels for the Cornering ABS and eight for the Ducati Traction Control (DTC).

More value to your passion

With Ever Red, the quality and reliability of the Ducati brand remain your inseparable travelling companions over time. Ever Red is the exclusive Ducati warranty extension programme. With its activation you can continue to feel protected for 12 or 24 months beyond the expiration of the Ducati Warranty (24 months). Ever Red includes roadside assistance for the entire coverage period and no mileage limits. In this way you can ride for all the kilometres you want, even abroad, enjoying your Ducati without any worries.

To find out if the Ever Red extension is available in your country and for further information contact your Ducati dealer or visit ducati.com.

Endless excitement

In designing each bike, Ducati constantly strives to ensure maximum reliability while reducing service costs. A commitment that has seen the intervals for the main Desmo Service, in which valve clearance is checked and adjusted if necessary, to be extended to 30,000 km for the Hypermotard 950.

Even the simplest of checks, such as the Oil Service, are extended to 15,000 km or 12 months. A considerable interval for such high performance engines, which only confirms the high quality standards adopted in terms of material selection and R&D processes. Ducati continuously invests in the technical training of its dealers.

The specific skills offered by the official Ducati Service network ensure that all those operations needed to keep every Ducati in perfect condition are thoroughly executed, while advanced equipment such as the Ducati Diagnosis System allows the software on each Ducati to be updated with the latest releases, ensuring that the electronics continue to perform at the maximum level.

Always by your side

One of Ducati's main goals is to offer every Ducatista the chance to enjoy unlimited and safe travel all over the world. To achieve this aim, Ducati offers a "fast delivery" original spares service, with delivery in 24/48 hours across 85% of the areas in which it operates. With a distribution network that covers more than 86 countries, thanks to 718 official Dealers and Service Points*, choosing a Ducati means you can travel worry free and in total freedom, wherever the road may take you, and count on support from our extensive Dealer network that ensures Ducati quality and professionalism is always close at hand.

718 Authorised dealers and service points

86 World countries

*Information updated as of July 2019



Ever Red
Extended Warranty



*Equal to 18,000 miles.



Technical data and equipment



HYPERMOTARD 950

Dimensions

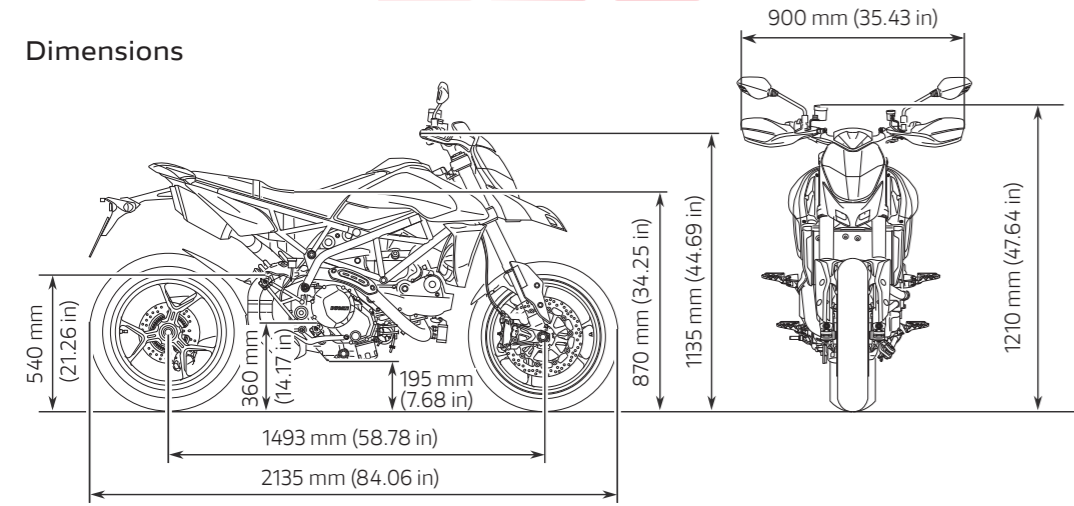

Power and torque

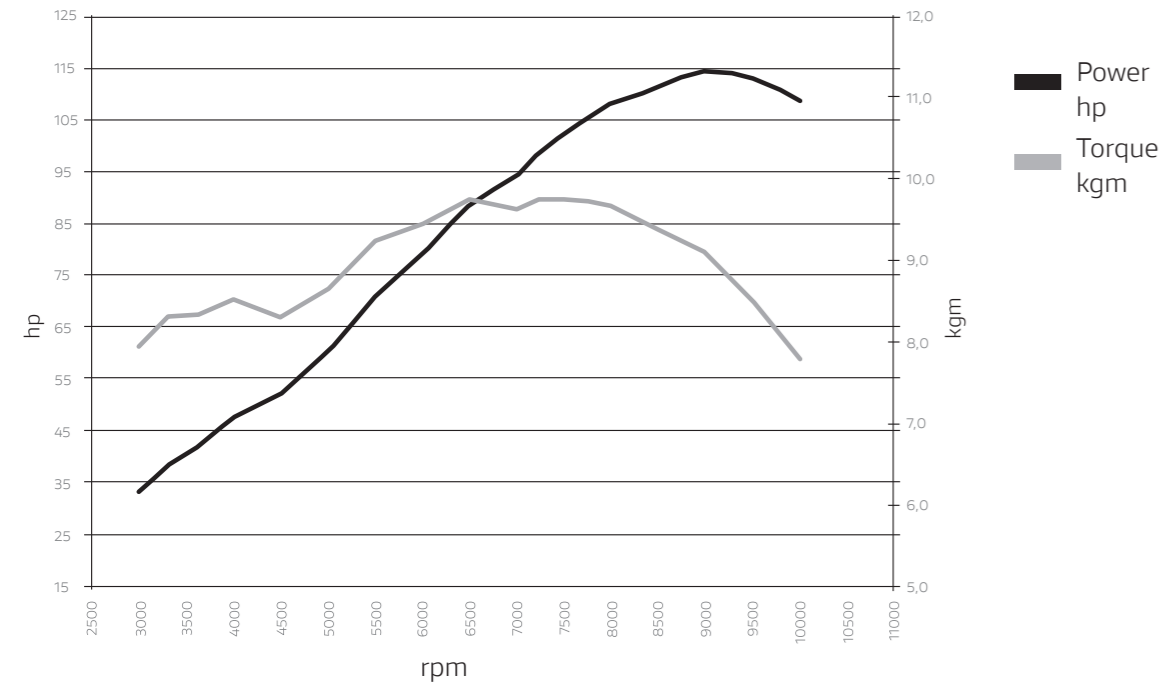

Engine

Engine Testastretta 11°, L-Twin cylinder, 4 valve per cylinder, Desmodromic, liquid cooled, magnesium head covers, hydraulic clutch command

Displacement 937 cc

Bore X stroke 94 x 67,5 mm (3,70 x 2,66 in)

Compression ratio 13,3:1

Maximum power 114 hp (84 kW) @ 9.000 rpm

Maximum torque 71 lb-ft (96 Nm) @ 7.250 rpm

Fuel injection Electronic fuel injection system, Ø 53 mm throttle bodies with full Ride by Wire system

Exhaust Double under-tail aluminum muffler; catalytic converter and two lambda probes.

Transmission

Gearbox 6 speed

Primary drive Straight cut gears; Ratio 1.85:1

Ratio 1=37/15 2=30/17 3=28/20
4=26/22 5=24/23 6=23/24

Final drive Chain; Front sprocket 15; Rear sprocket 43

Clutch Slipper and self-servo wet multiplate clutch, hydraulic control

Chassis

Frame Tubular steel Trellis frame

Front suspension Marzocchi aluminum fully adjustable, upside-down Ø 45 mm

Front wheel Y shaped 3-spoke light alloy 3.5" x 17"

Front tyre Pirelli Diablo Rosso III, 120/70 ZR17

Rear suspension Progressive linkage with adjustable spring preload and rebound damping Sachs monoshock. Aluminium single-sided swingarm

Rear wheel Y shaped 3-spoke light alloy 5.5" x 17"

Rear tyre Pirelli Diablo Rosso III, 180/55 ZR17

Wheel travel (front/rear) 170 mm (6.7 in) - 150 mm (5.9 in)

Front brake 2 x Ø 320 mm semi-floating aluminum flange discs, radially mounted Monobloc Brembo callipers, 4-piston 2-pad, radial pump with adjustable lever, with Cornering ABS

Rear brake Ø 245 mm disc, 2-piston calliper, with Cornering ABS

Instrumentation Full-TFT color display

Dimensions and Weights

Dry weight 178 kg (392 lb)

Kerb weight 200 kg (440 lb)

Seat height 870 mm (34.2 in)

Wheelbase 1493 mm (58,8 in)

Rake 25°

Front wheel trail 104 mm (4.1 in)

Fuel tank capacity 14.5 l (3.8 US gal)

Number of seats 2

Standard Equipment

Riding Modes, Cornering ABS, Ducati Slide by Brake, Ducati Traction Control (DTC) EVO, Ducati Wheelie Control (DWC) EVO, Power Modes, Ride-by-Wire, Day Time Running Light (DRL), Tapered aluminum handlebars, Removable passenger footpegs, USB power socket, Ready for: Anti-theft system, Ducati Quick Shift (DQS) up/down, Heated grips, Ducati Multimedia System (DMS).

Warranty

24 months unlimited mileage

Maintenance

Maintenance service intervals 15,000 km (9,000 mi)/12 months

Maintenance

Valve clearance adjustment 30,000 km (18,000 mi)

Emissions & Consumption*

Standard Euro 4

CO₂ Emissions 122 g/km

Consumption 5,1 l/100 km



Equal to 18,000 miles

Kilometers refer to the first Desmo Service, i.e. when the valve clearance is checked and adjusted if necessary.

* Only for countries where Euro 4 standard applies.

A 35 kW restricted power version of the Hypermotard 950 is available for restricted license holders. Please contact your dealer for information on availability.

HYPERMOTARD 950SP

	Hypermotard 950	Hypermotard 950 SP
Front suspension	Ø 45 mm Marzocchi fully adjustable aluminum fork	Ø 48 mm Öhlins fully adjustable fork
Rear suspension	Sachs monoshock adjustable in pre-load and rebound	Öhlins fully adjustable monoshock
Travel suspension front/rear	170 mm / 150 mm	185 mm / 175 mm
Wheels	Y-shape 3-spokes Aluminum alloy casted	W-shapes 3-spokes Marchesini Aluminum forged
Tires	Pirelli Diablo Rosso III	Pirelli Diablo Supercorsa SP
Ducati Quick Shift (DQS) Up/Down EVO	Accessory	Standard
Front mudguard	Plastic	Carbon fiber
Timing belt covers	Plastic	Carbon fiber
Seat height	870 mm	890 mm
Dry weight	178 Kg (392 lb)	176 Kg (388 lb)
Kerb weight	200 Kg (440 lb)	198 Kg (436 lb)



1 Headlight with Day Time Running Light (DRL)

4 Öhlins front fork



2 Rear Öhlins monoshock TTX36

5 Marchesini forged wheels



3 Ducati Quick Shift (DQS) up/down



HYPERMOTARD 950

Bodywork: Ducati Red
Frame: Ducati Red



HYPERMOTARD 950 SP

Bodywork: SP Livery
Frame: Ducati Red





Accessories

For more information about the accessories range, technical specifications and instructions, visit a Ducati Dealer or the Accessories section of the [ducati.com](https://www.ducati.com) site.





1 Complete exhaust assembly



2 Carbon heat guard



3 Billet aluminium tank cap



4 Type-approved silencers



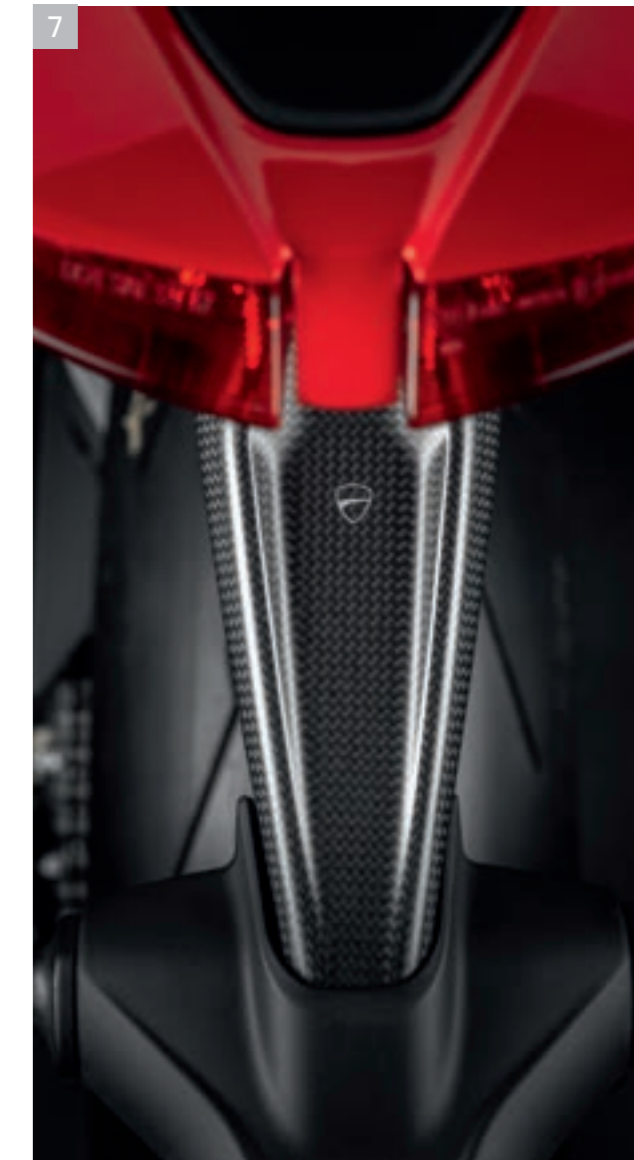
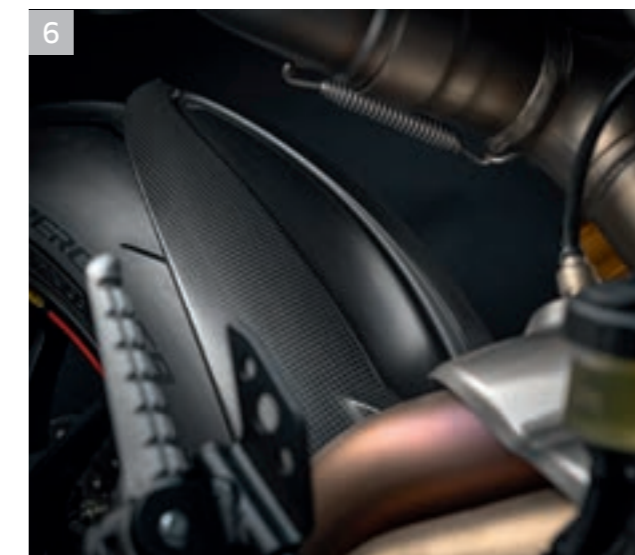

1 LH aluminium rear-view mirror - RH aluminium rear-view mirror ok A

2 Front fork slider A

3 Billet aluminium water pump cover A

4 Carbon fiber headlight fairing

5 Brake fluid reservoir - Clutch fluid reservoir ■ A

6 Carbon rear mudguard

7 Approved carbon number plate holder support

Key to symbols

 This product is designed exclusively for race bikes ridden on a closed racetrack. Its use on public roads is forbidden by law.

 For racing use only. The product marked with this symbol can only be used on competition vehicles. Use outside a competition track of motorcycles equipped with this product is prohibited by law. Verify any further restrictions with the relevant race course. Motorcycles equipped with this accessory are prohibited from operating on public roads.

A Anodized

 Red

PG Phantom Gray

M Matt

 Black

SWS Star White Silk

F Tinted

 Silver

T Clear

 This accessory is not approved for road circulation.

JPN This accessory cannot be used/sold in Japan.

OK Accessory type-approved for road use.

JPN Japan.

 Type-approved silencer according to Regulation (EU) No. 168/2013 of 15/01/2013

EU European.



ducati.com

Riding a motorcycle is the most exciting way to enjoy the road, and offering the utmost safety to the motorcyclist is Ducati's commitment. Ducati bikes are increasingly easy to handle, reliable and better equipped to guarantee maximum safety and enhance riding pleasure. Technical clothing is made with more and more advanced materials for adequate protection and increased visibility. The safety of motorcyclists is Ducati's commitment. For more information visit the safety section of the Ducati site (www.ducati.com).

Warning: The photos and technical information in this catalogue may refer to prototypes subject to modifications during production and are purely for illustration and reference purposes, and are therefore not binding on Ducati Motor Holding S.p.A. Sole Shareholder Company - Company subject to the direction and coordination of AUDI AG ("Ducati"). Ducati cannot be held responsible for any print and/or translation errors. This catalogue is transnational and therefore some products may not be available and/or their features may vary in accordance with local laws. Not all colours and versions are available in each country. Ducati reserves the right to make changes and improvements to any product without obligation of prior notice or to make such changes to products already sold. Further characteristics of the products are contained in the pertinent owner's manuals. The products represented are not definitive versions and are therefore subject to significant changes at Ducati's discretion without prior notice. The photographs published in this catalogue show only professional riders under controlled street conditions. Do not attempt to imitate such riding behaviour as it could be dangerous for you or other people on the road. This catalogue, including but not limited to the trademarks, logos, texts, images, graphics and table of contents herein, constitute Ducati intellectual property, or in any event Ducati has the right to reproduce it; any reproduction, modification or other whole or partial use of the catalogue or its contents, including publication on the Internet without the prior written consent of Ducati, is prohibited.

Actual fuel consumption may vary based on many factors, including but not limited to riding style, maintenance performed, weather conditions, surface characteristics, tyre pressure, load, weight of the rider and the passenger, accessories.

Ducati indicates the dry weight of the motorcycle excluding battery, lubricants and coolants for liquid-cooled models. The weights in running order are considered with all operating fluids, standard equipment and the fuel tank filled to 90% of its useful capacity (UE regulation no. 168/2013). October 2019.



WDW2020
WORLD DUCATI WEEK
17th - 19th July / Misano, Italy
wdw.ducati.com

Developed with



Technical partner

